

Model	ECM-50/CCFJ40J (60Hz)
Standby Power (60Hz)	44kW /55kVa
Prime Power (60Hz)	40kW /50kVa

Standard Features

General Features

- Marine Engine Cummins 4BTA3.9-GM65
- Heat Exchanger and Water Pump (for marine main power)
- Radiator (standard for marine emergency power genset or optional for marine main power genset)
- 24V battery and charger (optional)
- Alternator (Marathon, ABB, Siemens or Equal), single bearing alternator IP23/IP44, insulation class H/H
- Absorber
- Standard control panel
- Muffler (optional)
- Start batteries, rack and cable (optional)
- Ripple flex exhaust pipe, exhaust siphon, flange
- Soundproof Canopy (optional)
- Air Start or Spring Start or Double Electrical Start (optional for emergency power genset)
- Tools kits
- User manual



General Ratings

Voltage	Hz	Phases & Wires	P.F (COS ϕ)	Rated Current (Amps)	Standby Ratings (kW/kVa)	Prime Ratings (kW/kVa)
440	60	3 & 3	0.8	66	44/55	40/50
480	60	3 & 3	0.8	60	44/55	40/50

Remarks: Other special voltage requirements are available.

Standards

- GB/T13032-1991, ISO9001:2008 and CE Quality Control System.
- As to Classification Society, Ettes Power supply CCS as standard; ABS, BV, DNV-GL or LR is optional.

Sales Promises

Ettes Power provides a full line of brand new and high quality products. Warranty 12 months or 1,500 running hours, which is subject to the earlier one. Furthermore, all Cummins engines are covered by Cummins Global-United warranty and distributor service network.

Marine Diesel Engine Data

Engine Brand	Cummins
Engine Model	4BTA3.9-GM65, 4 Stroke, Water Cooled.
Number of Cylinders	4 cylinders in line
Aspiration	Turbocharged and After-cooled
Bore x Stroke	102 x120 mm
Rated Speed	1800 RPM
Displacement	3.9 L
Prime Power	65kW /87HP
Speed Governor	Electrical
Cooling System	By heat exchanger
Fuel Consumption at 100% Load	217 g/kw.h
Starter Motor	DC24V
Emission Standard	IMO TIER II, EIAPP Certificate

Alternator Specification

Alternator Brand	Marathon, ABB, Siemens or Equal
Alternator Model	MP-H-40-4
Power Capacity	68 kVa
Efficiency	86.8%
Type	Brushless, Self-excited and AVR
Power factor	0.8
Insulation Grade	H
Protection Grade	IP23(IP44 is optional)
Phase / wire	3 phase 3 wires

Standard Control Panel

Standard Control Panel **KCM II G** (originally coming from Cummins)

- ▶ engine start/stop
- ▶ engine coolant temperature
- ▶ oil pressure and temperature
- ▶ tachometer
- ▶ coolant temperature alarm
- ▶ oil pressure alarm
- ▶ battery charging indicator
- ▶ generator to be protection from overload and overheat
- ▶ other basic functions of monitoring and alarm



Optional Control Panel

Free Standing Control Cabinet, Controller ENDA or Smartgen Series or equal, which has the following features.

- ▶ Microcomputer digital control
- ▶ Digital display of parameters of diesel engine, and integration of measuring and monitoring
- ▶ Modularization of functional configuration, and integration of product structures
- ▶ Resistance to vibration, humidity, salt mist and high/low temperature
- ▶ Powerful ability to resist interference, convenient installation and use, and high performance-price ratio
- ▶ Automatic zero set of lubricating oil pressure.
- ▶ Remote monitoring of running parameters;
- ▶ Accumulation of running period of diesel engine
- ▶ Indicators of lube oil temperature; Lube oil pressure, Water temperature, Engine speed; Battery voltage; Engine run-time (Hours)



Standard Supply Scope

Complete standard open type marine diesel genset including:

- Engine
- Alternator
- Base Frame and Elastic Coupling
- Heat exchanger and sea water pump (for marine main power)
- Radiator (standard for marine emergency genset or optional for marine main genset)
- Standard control system
- Technical documents (user books, parts catalog, drawings and diagrams)
- Bench testing report
- CCS and EIAPP certificates

Optional Equipment

Engine	Alternator
<ul style="list-style-type: none"> ● Water Separator ● Water and Oil Heater ● Air Start or Spring Start or double electrical start (for emergency genset) ● Battery and Charger ● Exhaust Silencer 	<ul style="list-style-type: none"> ● Anti Condensation Heater ● Permanent Magnet Generator(PMG) ● Drop CT(For Paralleling)
Control System	Others
<ul style="list-style-type: none"> ● Switchboard (circuit breaker) ● (ATS) Control Panel (for emergency genset) ● Parallel Control Panel 	<ul style="list-style-type: none"> ● Free Standing Fuel Tank ● Soundproof Canopy ● Rainproof Canopy ● Fire Fighting System ● Extra Spare Parts for future maintenance

Marine Classification Society Certification

Ettes Power will supply CCS (China Classification Society) as standard, which is the member of IACS (the International Association of Classification Societies) and chaired IACS Council respectively in 1996-1997 and 2006-2007.

And, Ettes Power can also apply special certificates such as ABS, BV, DNV-GL or LR etc. according to the client's special requirements.

Dimension & Weight

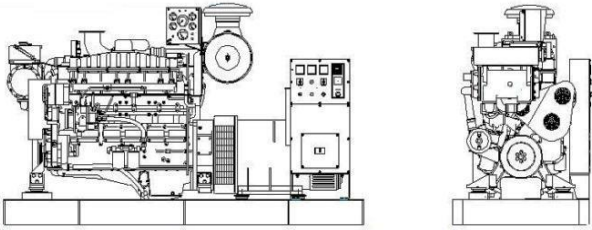
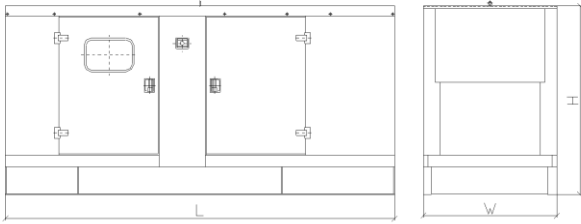
	<p align="center">Standard Configuration (Open Type)</p> <p>Overall Size: 1500(mm)×750(mm)×1320(mm)</p> <p>Weight: 1100 kg</p>
	<p align="center">Soundproof Type</p> <p>Overall Size: to be confirmed</p> <p>Weight: to be confirmed</p>

